

INSTRUCTION MANUAL

DIGITAL DIESEL METER

L-DTFM



DIGITAL DIESEL METER

L-DTFM

INTRODUCTION

TECHNICAL DATA

1. The liquids compatible with turbine digital meter must be at low viscosity, namely:

- Diesel fuel
- Kerosene

Use of other fluids may be inaccurate and can damage the meter

2. Flow Rate: 10-100LPM/3-26GPM, flow rates outside of this range may be inaccurate.

3. Operating pressure: 72PSI/5BAR

4. Inlet/Outlet: 1" BSP (F)

Not suitable when used in a retail sale of diesel and kerosene!

LCD DISPLAY

The "LCD" of the meter features two numerical registers and various indications displayed to the user only when the applicable function so requires

KEY

1. Partial register (5 figures with moving comma from 0.1 to 99999)

Indicating the volume dispensed since the reset button was last pressed.

2. Indication of battery charge
3. Indication of calibration mode
4. Indication of resetting present total to Zero
5. Total register
6. Indication of flow rate mode
7. Indication of unit of measurement of partial:

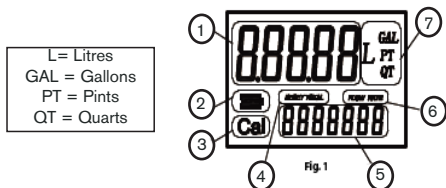

USER BUTTONS

The turbine digital meter features two buttons (MENU and RESET) which individually perform two main functions and together, other secondary functions.

The main functions performed are:

For the reset key, resetting the partial Register and reset table total (reset total)

For the menu key, entering instrument calibration mode.

Used together, the two keys permit entering configuration mode.

BATTERY REPLACEMENT

When replacing the battery, please open the cover, remove the plug and replace the battery.

INSTALLATION

The inlet and outlet for this meter is 1" BSP. The meter can be easily connected to a pipe or nozzle.

OPERATION

1. BUTTON USAGE:

Calibration and Measurement Unit Change.

• **Reset the present total (See Fig. 2)**

- 1) When the meter is on standby, press the RESET key.
- 2) The display shows all the segments.
- 3) The meter resets the present total already.



Fig. 2

Show current correction factor and general total (Fig 3)

Press MENU and RESET together and hold for two seconds.

Value "1.4000" is the correction factor which can be reset; "1234567" is the general total which cannot be reset.



Fig. 3

Measurement unit change (Fig. 4)

Press MENU and RESET together and hold for five seconds.

Zone 7 on the display is the current unit. Press RESET to chose a different measurement unit and then press MENU to confirm.

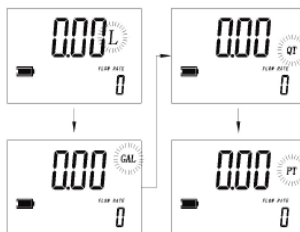

Fig. 4

2. RESET THE RESETTABLE TOTAL (FIG. 5)

When the meter is on standby, press the RESET key for 2 seconds to reset the present total first.

DIGITAL DIESEL METER

L-DTFM

3. PROCEDURE FOR ENTER THE CORRECTION FACTOR DIRECTLY

Carefully follow the procedure indicated below.

FORMULA

Proper correction factor = current correction factor × (actual value / display value)

Example:

Actual value 20.75

Display value 18.96

Current correction factor 1.000

Proper correction factor $1.000 \times (20.75 / 18.96) = 1.000 \times 1.094 = 1.094$

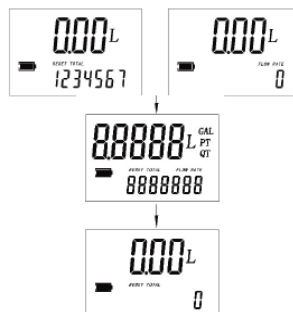











Fig. 5

1	Wait for the meter to go to standby	
2	Reset the resettable total	
3	Press the MENU key. Keep it pressed until similar to the image shown (digit will flash) the correction factor can now be modified	
4	Press the RESET key to choose the right digit from 0 to 9. Press the MENU key to start the next digit. So the digit of correction factor can be changed one by one.	
5	Make sure the correction factor is right, press the MENU key. Keep it pressed until quit calibration mode, the factor is saved. The meter goes to standby again.	

4: MODIFY THE CORRECTION FACTOR IN FIELD

PLEASE CAREFULLY FOLLOW THE PROCEDURE INDICATED BELOW.

1	Wait for the meter to go to standby.	
2	Reset the resettable total.	
3	Start dispensing into a measuring glass. Stop when 5 Litres of volume is reached, read out the Actual value. The volume displayed on the LCD is the Display Value, not the Actual Value. For example, in the figure on the right, the Display Value is 18.96 while the Actual Value is 20.75.	
4	Press the MENU key. Keep it pressed until showed as the right fig., the digit flash, Press the RESET key to choose the right digit from 0 to 9. Press the MENU key to go the next digit so that the Actual Value can be input.	
5	Make sure the correction factor is right and then press the MENU key. Keep it pressed until calibration is finished and the factor is save. The meter will then return to standby.	

DIGITAL DIESEL METER

L-DTFM

TROUBLE SHOOTING GUIDE

PROBLEM	CAUSE	SOLUTION
LCD: no display	Bad battery contact	Check battery contacts
Inaccurate reading	Incorrect Factor	With reference to paragraph 3 & 4, check the FACTOR
	The meter works below the minimum acceptable flow rate	Increase the flow rate until an acceptable flow rate range has been achieved
Reduced or zero flow rate	Turbine blocked or jammed	Clean the turbine
The meter does not count, (fluid is passing through meter)	Possible electronic card problems	Replacement meter required

PARTS LIST

NO.	DESCRIPTION	QTY.
1	Meter Cover	1
2	Rubber Protection	1
3	Self-tap screw ST2.9X9.5	2
4	Battery Holder	1
5	Electric Board	1
6	Battery CR2	1
7	Self-tap screw ST2.2X6.5	3
8	Meter body	1
9	Self-tap screw ST2.9X13	4

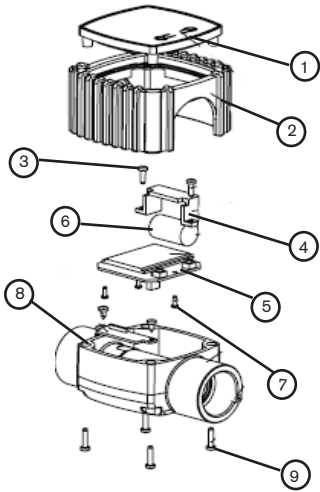

For Warranty Terms and Conditions refer to www.lubematebymacnaught.com.au