

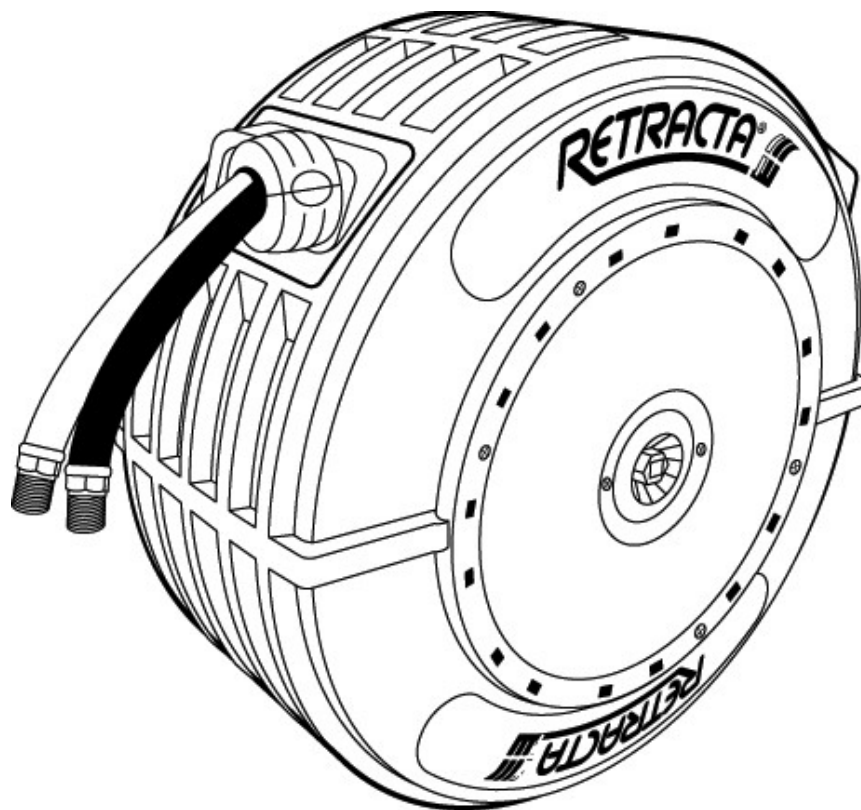

Oxy / LPG Hose Reel

Owners Manual



Includes Models
OG215K OGC215K

Premium Hose Reels

IMR30LPG-issue 6

INTRODUCTION

Thank you for purchasing the Retracta R3 retractable hose reel.

PLEASE READ THIS SAFETY INFORMATION CAREFULLY BEFORE USE.

Read and retain this instruction manual to assist you in the operation of your new product.



'CAUTIONS' are listed throughout this manual to advise of actions that may cause damage to the operator or to the equipment.

you're

- Operation and maintenance of Oxy-Fuel Gas equipment should conform to the provisions of the American National Standard Z49-1 "Safety in Welding and Cutting".
- Leak test all connections and hose reel swivels prior to initial use (refer "Gas Leak Test Procedure")
- It is recommended that leak tests on all equipment be carried out at least once a month, on the replacement of gas cylinders and after any maintenance procedure.
- For O-Ring seal lubrication use **only 'HYPALUBE A514' or an equivalent inert lubricant** when required. **DO NOT** allow oil or grease to come in contact with the swivel or Oxy-Fuel gas equipment.



CAUTION

ONLY use this Retracta reel for the Oxy Fuel gas combination.

DO NOT use equipment in poorly ventilated areas.

EXAMINE the hose, reel swivel and other equipment for damage (including leaks) should a "Flashback" occur. Replacement of swivel seals is recommended. The use of "Flashback" check valves to reduce the risk of backflow and "Flashback" is also recommended.

ONLY genuine Retracta R3 replacement parts.

DO NOT use pipe fitting compounds or thread lubricants in making connections.

DO NOT direct the gas flame at the hose or hose reel.

DO NOT exceed the recommended maximum LPG draw off rate from the cylinder and only operate when the cylinder is upright. LPG contained in the cylinder can escape and damage the hose, hose reel seals and other equipment.

GAS LEAK TEST PROCEEDURE



Note: Before attempting any maintenance, disconnect and turn off supply line then release line pressure.

Test each hose line separately and ensure that all connections are tight.

- 1) Close both torch valves.
- 2) Open the Oxygen cylinder valve and adjust delivery pressure to 25psi or more.
- 3) Close the Oxygen valve, check guage to ensure no pressure drop. If there is drop in pressure, check all connections, then re-pressure and test all the connections including hose, by brushing with warm soapy water solution looking for the presence of any bubbles.
- 4) Open the Oxygen valve at the torch and re-close to vent the Oxygen line. Repeat steps 1, 2 and 3 with the LPG, with the delivery pressure set at 10 psi. Vent the LPG line.
- 5) Replace or repair any faulty items immediately and repeat 'Leak test' procedure.



CAUTION

Test the system and all connections for leaks prior to use. Re-test the system frequently (once per month approx) and on each change of gas cylinder or after maintenance.

INSTALLATION INSTRUCTIONS

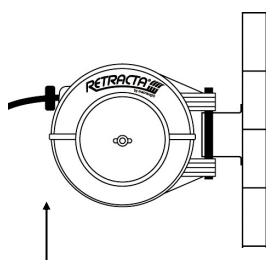

Fig.1 Wall mounting (max height 1.4m)

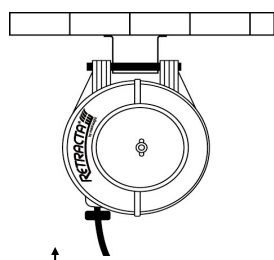

Fig.2 Overhead mounting (max height 4.5m)

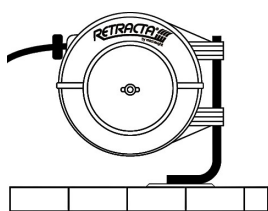

Fig.3 BB100 Bracket - Floor/Bench

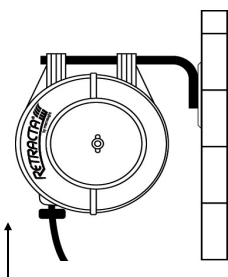

Fig.4 BB100 Bracket High wall mounting (max height 4.5m)

- 1) Use appropriate hardware to secure and support the reel and bracket to desired location and weight of the fluids.

(refer to back page for mounting bracket template)

- 2) Prevent the reel from swiveling in the overhead position (figure 2) by install locking bracket RB9 (supplied).
- 3) If spring recoil tension requires adjusting refer to "Add spring tension" for correct procedure
- 4) Connect the fluid supply line to the side of the reel making sure to tighten appropriately.
- 5) It is recommended that an isolation valve is installed before the reel inlet.
- 6) Connect a desired hose-end attachment and tighten appropriately. Thread sealant may be required.
- 7) Purge the air from the reel and check for any leaks or damage before initial use.
- 8) Before carrying out any maintenance, close isolation valve and remove all line pressure.



CAUTION

Before attempting any maintenance disconnect and turn off supply line, then release the line pressure.



INCREASE SPRING TENSION

- 1) Remove screws

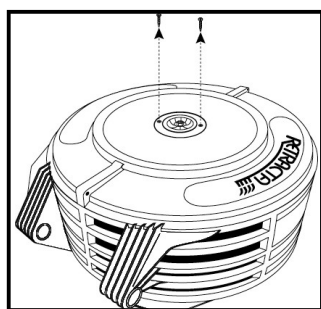

- 2) Add 2 complete turns
Note: 1 click on hub equals 90 deg

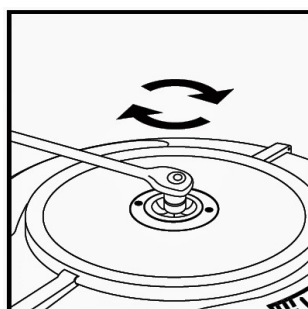

- 3) Replace screws

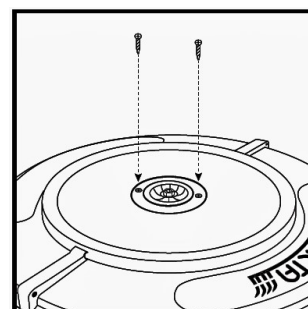

HOSE REPLACEMENT INSTRUCTIONS



CAUTION



Before attempting any maintenance disconnect and turn off supply line, then release the line pressure.

Note: After replacing the hose it is important that you carry out the leak test procedure as listed on page 2

1) Pull out hose and latch

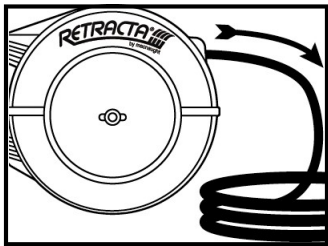

2) Remove screws

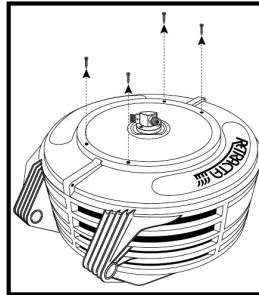

3) Remove sideplate

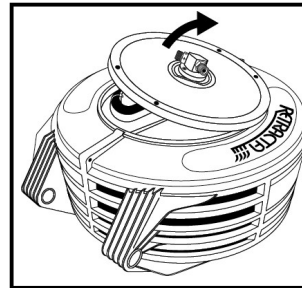

4) Remove cable tie

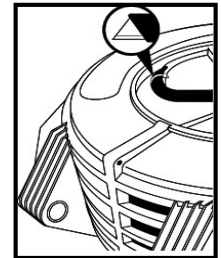

5) Remove hose from swivel

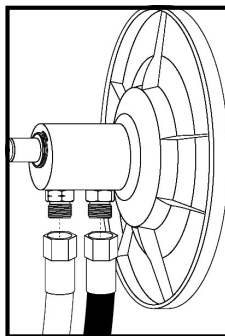

6) Remove old hose

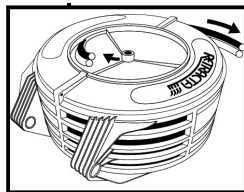

7) Fit new hose

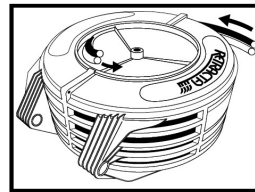

8) Fit hose to swivel

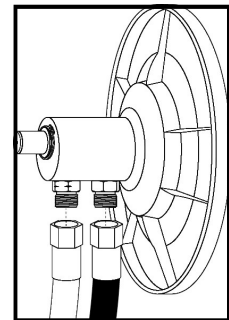

9) Fit cable tie

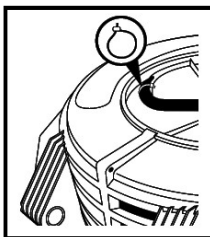

10) Fit side plate

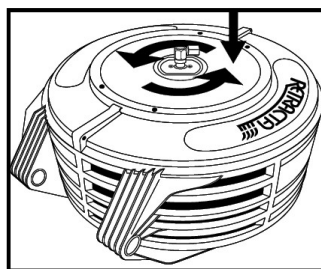

11) Fit screws.

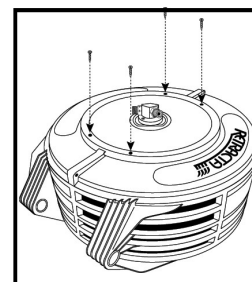

12) Recoil hose evenly into reel

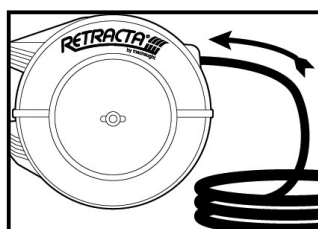

CAUTION

Test reel for leaks prior to any use

SWIVEL SEAL REPLACEMENT INSTRUCTIONS



CAUTION

Before attempting any maintenance disconnect and turn off supply line, then release the line pressure.



Note: After replacing swivel or swivel seals it is important that you carry out the leak test procedure as listed on page 2

1) Pull out hose and latch

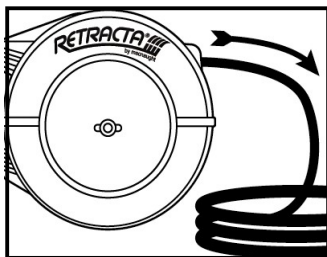

2) Remove screws

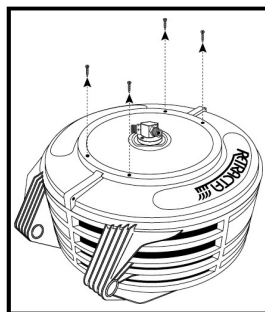

3) Remove sideplate

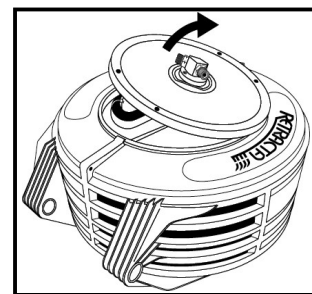

4) Remove cable tie

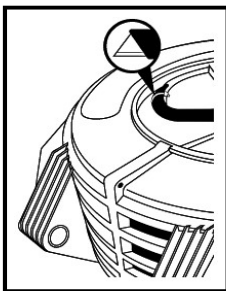

5) Remove circlip

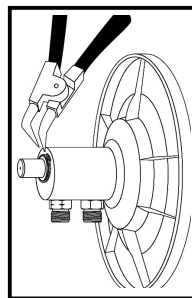

6) Remove swivel body

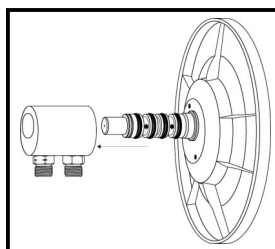

7) Carefully replace o'rings

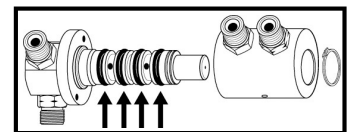

8) a) Apply grease to o'rings
(only use 'HYPALUBE A514' or equivalent grease)
b) Fit swivel body

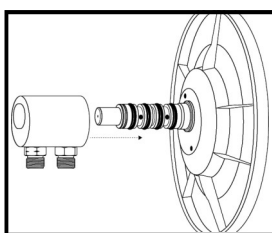

9) Fit circlip

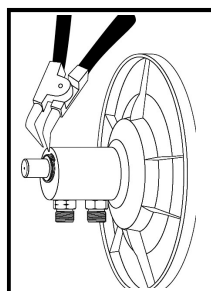

10) Fit cable tie

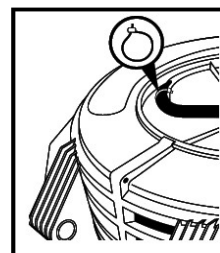

11) Fit side plate

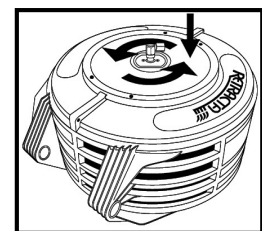

12) Fit screws.

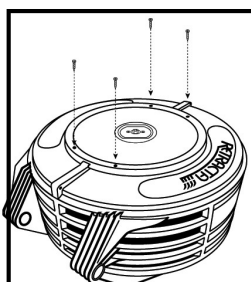

13) Recoil hose evenly into reel

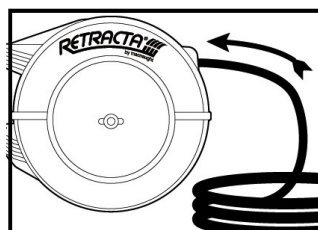

CAUTION

Test reel for leaks prior to any use

SWIVEL REPLACEMENT INSTRUCTIONS



CAUTION

Before attempting any maintenance disconnect and turn off supply line, then release the line pressure.



Note: After replacing swivel it is important that you carry out the leak test procedure as listed on page 2

1) Pull out hose and latch

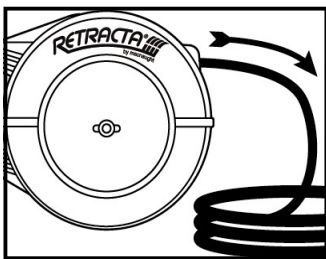

2) Remove screws

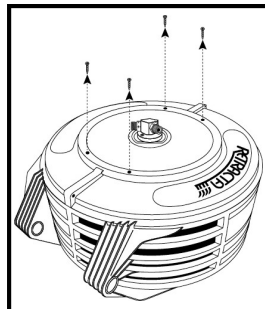

3) Remove sideplate

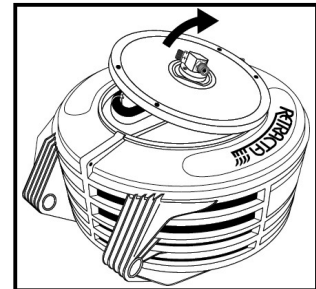

4) Remove cable tie

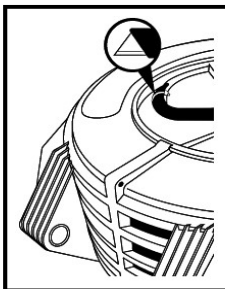

5) Remove hose

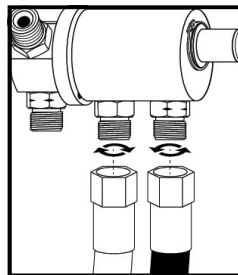

6) Remove circlip

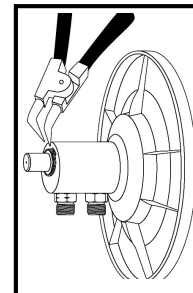

7) Remove swivel body

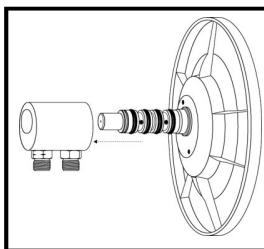

8) Remove screws

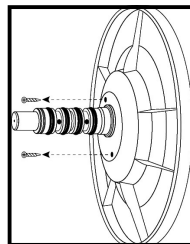

9) Remove swivel shaft

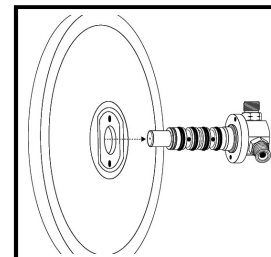

10) Fit new shaft

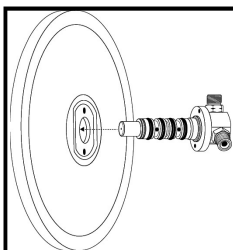

11) Fit screws

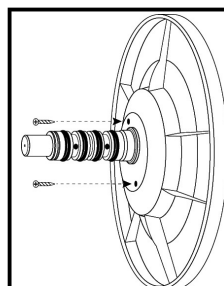

12) a) Apply grease to o-rings
(only use 'HYPALUBE A514' or equivalent grease)
b) Fit swivel body

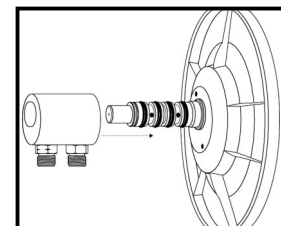

SWIVEL REPLACEMENT INSTRUCTIONS

13) Fit hose

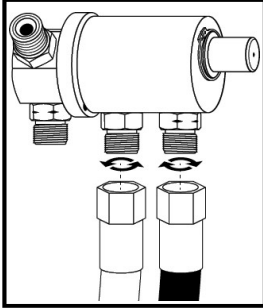

14) Fit circlip

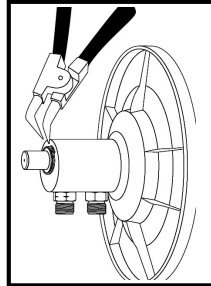

15) Fit cable tie

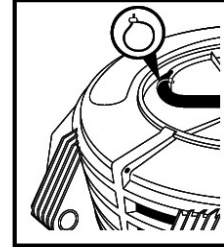

16) Fit side plate

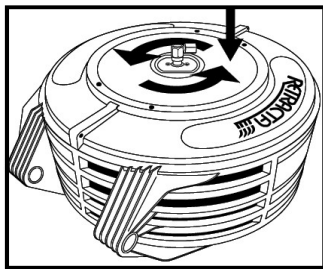

17) Fit screws.

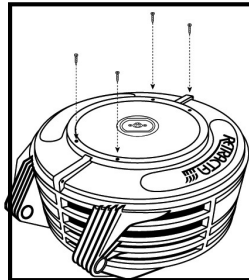

18) Recoil hose evenly into reel

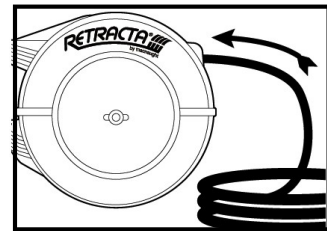

CAUTION

Test reel for leaks prior to any use

REMOVE / REPLACE TENSION SIDE PLATE

Before attempting any maintenance disconnect and turn off supply line, then release the line pressure.



1) Remove screws with magnetic screwdriver

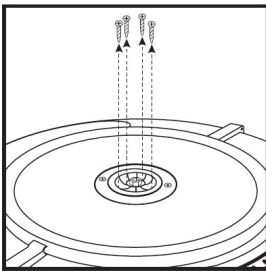

2) Hold hub and remove screws

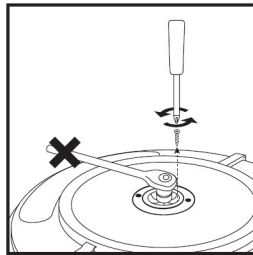

3) Release spring tension

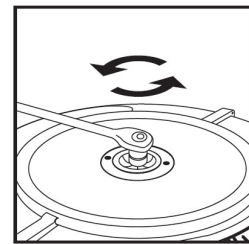

4) Remove screw and center hub

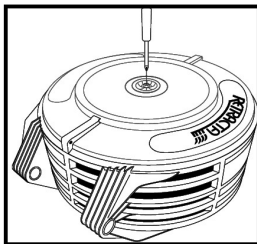

5) Remove screws.

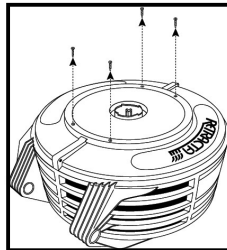

6) Remove side plate

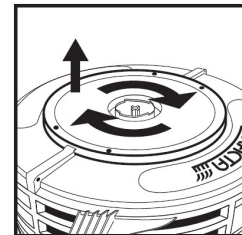

7) Fit new side plate.

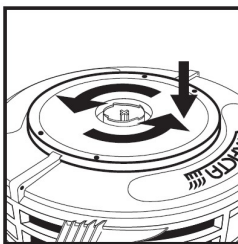

8) Fit screws.

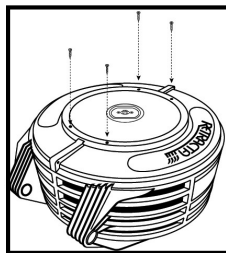

9) Fit screws

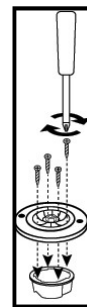

10) Fit screw.

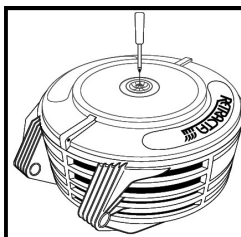

11) Add 2 complete turns

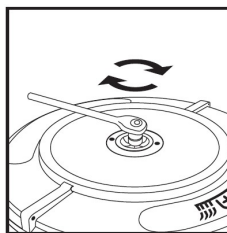

12) Fit screws

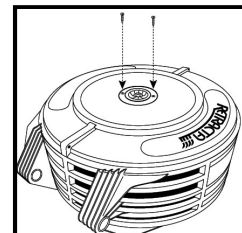

For models fitted with RACR
**RACR ADJUSTMENT
CONTROL INSTRUCTIONS**

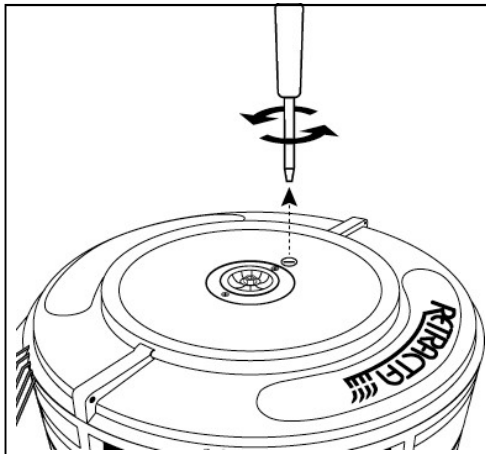
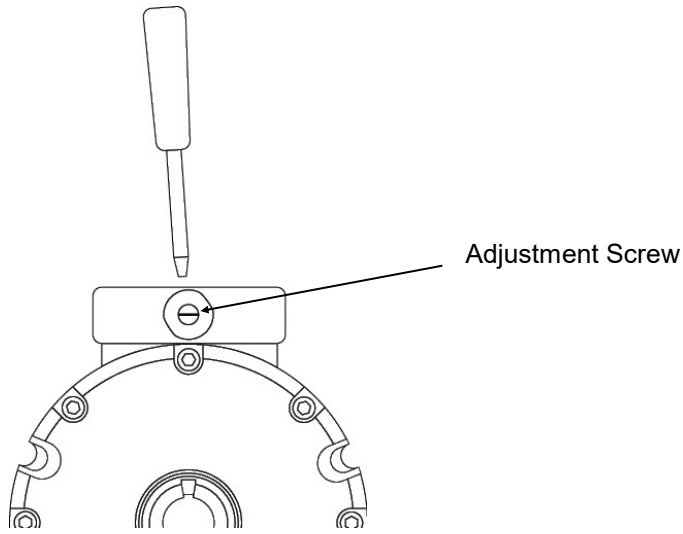

1. Remove the cover screw

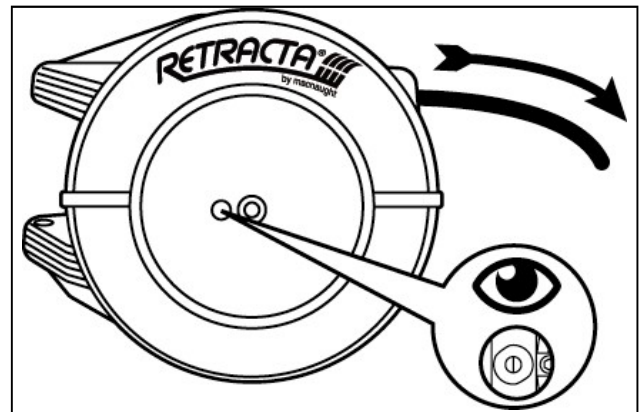

2. Pull hose out and latch when adjustment screw appears

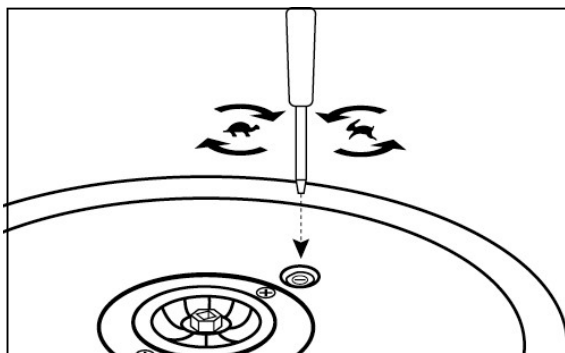

3. Adjust speed as desired

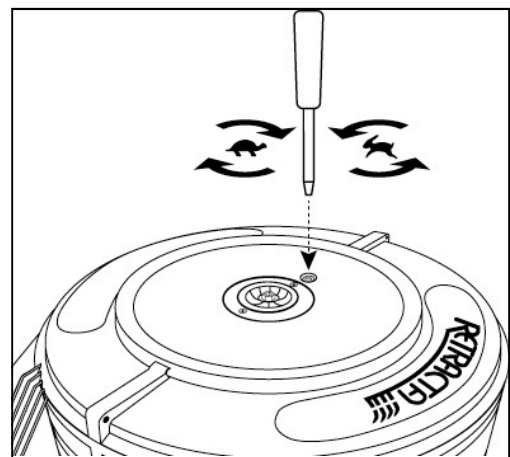

4. Replace the cover screw

TROUBLESHOOTING GUIDE



<p>Hose does not retract correctly</p>	<p>A) Outlet nozzle, gun or tool is too heavy</p> <p>B) Spring is fatigued and lost tension</p>	<p>Refer to INCREASE SPRING TENSION on page 3</p>
<p>Reel does not latch</p>	<p>A) Incorrect operation</p> <p>B) Latch assembly is broken</p>	<p>Refer to REMOVE/ REPLACE TENSION SIDE PLATE on page 8</p>
<p>Leaking from hose</p>	<p>Split in hose</p>	<p>Refer to HOSE REPLACEMENT on page 4</p>
<p>Leaking from swivel</p>	<p>Swivel or swivel seals are worn</p>	<p>Refer to SWIVEL OR SWIVEL SEAL REPLACEMENT on page 5 or 6</p>



CAUTION

Test reel for leaks prior to any use

REFER TO : Page 5
 SWIVEL OR SWIVEL SEAL REPLACEMENT INSTRUCTIONS

Swivel Assembly

OXY / LPG

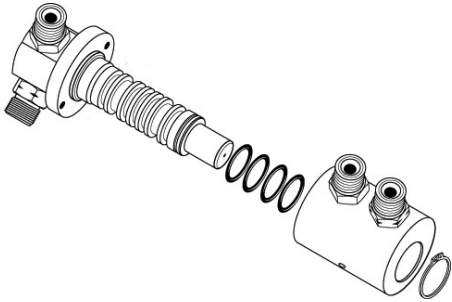

**O'Ring seal kit
 OLPG-1K**

**Swivel Assembly kit
 RS123Bs**

SPARE PARTS LIST

OXY LPG

Item no	Description	Spare part no
1	Tension hub set	R3THs
2	Latch set	R3Ls
3	Latching side plate	R3LPs
4	Inlet side plate	R3IPs
5	Drum assembly	R3DAs
6	Mouth set	R3Ms
7	Standard Bracket (incl locking plate)	BU200
8	Outer Casing Set - nom color	R3OC-color
9	Lower insert (nom colour)	R3LIS-color

SWIVEL ASSEMBLIES

10	Oxy LPG swivel assembly	RS123Bs
----	-------------------------	---------

SWIVEL SEAL KITS

12	Swivel seal set Oxy LPG (not shown)	OLPG-1K
----	-------------------------------------	---------

HOSE STOPPERS

	Spare part no
Gas reel	RP156-4s

HOSE ASSEMBLIES

1/4"x 15m - Oxy LPG	RH60s
---------------------	-------

Wall Bracket

Wall bracket (not shown)	BU200
--------------------------	-------

Exploded Diagram

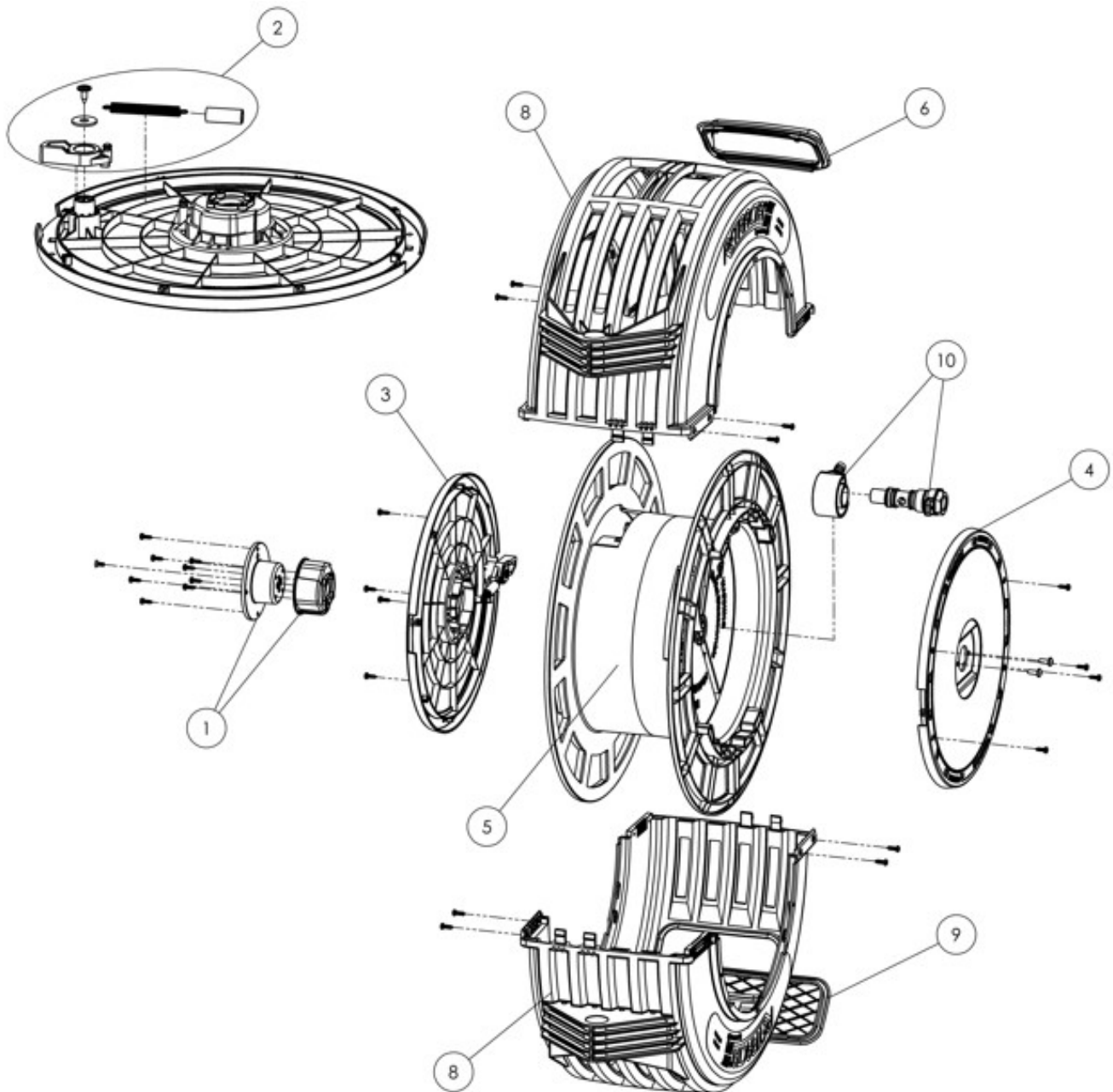

Note:

1. Outer casing set is supplied with screws, mouth set and lower insert
2. Standard bracket not shown

DECLARATION OF CONFORMITY





EN (English)		Declaration of Conformity	
We:	Macnaught Pty Ltd	Of:	41-49 Henderson Street, Turrella NSW 2205, Australia
Declare that:	Retracta Hose Reel models prefixed AR, ARC, ARG, ARGC, AW, CL, CLC, CW, CWC, DR, DRC, FRAS, GR, GRC, HP, HPC, HW, HWC, LPG, LPGC, OA, OAC, OG, OGC, OMP, OMPC, RO, ROC, RY, RYC, WD & WDC		
In accordance with:	2006/42/EC 2009/127/EC	(The Machinery Directive) (amending Directive - WD, DR & DRC models only)	
has been designed and manufactured to the following specifications:			
	EN ISO 12100: 2010	(Safety of Machinery)	
I hereby declare that the equipment named above has been designed to comply with the relevant sections of the above referenced specification. The product complies with all essential requirements of the Directives.			
Signed By:			
	Marco Uccellani, Engineering Manager, Macnaught Pty Ltd.		
Done at:	Macnaught Pty Ltd. 41-49 Henderson Street, Turrella, NSW 2205, Australia.		
Date:	26/08/2021		<small>COM-DINGP/CE-33_31 QA-CH149 Issued by: S.Chen</small>



FR (French)		Déclaration de conformité	
Nous,	Macnaught Pty Ltd,	41-49 Henderson Street, Turrella NSW 2205, Australie	
Déclarons que	Les modèles d'enrouleurs de tuyaux Retracta aux préfixes AR, ARC, ARG, ARGC, AW, CL, CLC, CW, CWC, DR, DRC, FRAS, GR, GRC, HP, HPC, HW, HWC, LPG, .LPGC, OA, OAC, OG, OGC, OMP, OMPC, RO, ROC, RY, RYC, WD et WDC		
en vertu de :	2006/42/CE 2009/127/CE	(directive Machines) (directive modificative - modèles WD, DR et DRC uniquement)	
sont conçus et fabriqués selon la spécification suivante :			
	EN ISO12100: 2010	(sécurité Machines)	
Je déclare par la présente que les équipements mentionnés ci-dessus sont conformes aux sections appropriées de la spécification susmentionnée. Le produit est conforme à toutes les exigences principales des directives.			
Signé par :			
	Marco Uccellani, responsable de l'ingénierie, Macnaught Pty Ltd.		
Fait à :	Macnaught Pty Ltd. 41-49 Henderson Street, Turrella, NSW 2205, Australie		
Date :	26/08/2021		<small>COM-DINGP/CE-33_31 QA-CH149 Métré par: S.Chen</small>

DE (German)		Konformitätserklärungen	
Wir,	Macnaught Pty Ltd	mit Sitz in:	41-49 Henderson Street, Turrella NSW 2205, Australien
erklären, dass	die Retracta Schlauchtrommelmodelle mit den Präfixen AR, ARC, ARG, ARGC, AW, CL, CLC, CW, CWC, DR, DRC, FRAS, GR, GRC, HP, HPC, HW, HWC, LPG, LPGC, OA, OAC, OG, OGC, OMP, OMPC, RO, ROC, RY, RYC, WD und WDC		
in Übereinstimmung mit den Verordnungen:	2006/42/EG 2009/127/EG	(Maschinenrichtlinie) (Änderungsrichtlinie, nur Modelle WD, DR und DRC)	
gemäß folgenden Spezifikationen konzipiert und hergestellt worden sind:			
	EN ISO12100: 2010	(Maschinensicherheit)	
Ich erkläre hiermit, dass die oben genannten Geräte so konzipiert wurden, dass sie mit den einschlägigen Abschnitten der oben genannten Spezifikation übereinstimmen. Das Produkt erfüllt alle grundlegenden Anforderungen der Richtlinien.			
Unterzeichnet von:			
	Marco Uccellani, Manager Ingenieurwesen, Macnaught Pty Ltd.		
Unternehmen, Ort:	Macnaught Pty Ltd. 41-49 Henderson Street, Turrella, NSW 2205, Australien.		
Datum:	26/08/2021		<small>COM-DINGP/CE-33_31 QA-CH149 Herangezogen von: S.Chen</small>

DECLARATION OF CONFORMITY



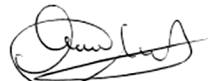



ES (Spanish)		Declaraciones de	
Nosotros:	Macnaught Pty Ltd	De	41-49 Henderson Street, Turrella NSW 2205, Australia
Declaramos:	Modelos Retracta Hose Reel con prefijo AR, ARC, ARG, ARGC, AW, CL, CLC, CW, CWC, DR, DRC, FRAS, GR, GRC, HP, HPC, HW, HWC, LPG, LPGC, OA, OAC, OG, OGC, OMP, OMPC, RO, ROC, RY, RYC, WD & WDC		
en conformidad con:	2006/42/EC 2009/127/EC		(La Directiva sobre maquinaria) (Directiva modificativa: solo los modelos WD, DR y DRC)
ha sido diseñada y fabricada de acuerdo con las siguientes especificaciones:			
	EN ISO 12100: 2010		(Seguridad de la maquinaria)
Por la presente declaro que el equipo mencionado anteriormente ha sido diseñado para cumplir con las secciones pertinentes de las especificaciones mencionadas con anterioridad. El producto cumple con todos los requisitos esenciales de las Directivas.			
Firmado por:			
	Marco Uccellani, Responsable de ingeniería, Macnaught Pty Ltd.		
Redactado en:	Macnaught Pty Ltd, 41-49 Henderson Street, Turrella, NSW 2205, Australia.		
Fecha:	26/08/2021		
			<small>COM-DIRECTIVE-01_R1 QA-C07049 modificado por R.2021</small>

JA (Japanese)		適合宣言書	
当社	Macnaught Pty Ltd	所在地	41-49 Henderson Street, Turrella NSW 2205, Australia
は、次の製品が以下の指令及び仕様に準拠して設計、製造されていることを宣言します。			
製品:	AR、ARC、ARG、ARGC、AW、CL、CLC、CW、CWC、DR、DRC、FRAS、GR、GRC、HP、HPC、HW、HWC、LPG、LPGC、OA、OAC、OG、OGC、OMP、OMPC、RO、ROC、RY、RYC、WD、WDCの各種Retractaホースリールモデル		
指令:	2006/42/EC		(機械指令)
	2009/127/EC		(指令の修正 - WD、DR、DRCモデルのみ)
仕様:	EN ISO12100: 2010		(機械の安全性)
私は、上記の製品が上記仕様の関連セクションに適合するように設計されていることをここに宣言します。この製品は、本指令のすべての必須要求事項に準拠しています。			
署名:			
	Marco Uccellani, 技術管理者, Macnaught Pty Ltd		
住所:	Macnaught Pty Ltd, 41-49 Henderson Street, Turrella, NSW 2205, Australia.		
日付:	2021年08月26日		
			<small>COM-DIRECTIVE-01_R1 QA-C07049 改発行 2021</small>

DECLARATION OF CONFORMITY



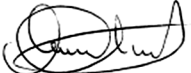

EN (English)		Declaration of Conformity	
We:	Macnaught Pty Ltd	Of:	41-49 Henderson Street, Turrella NSW 2205, Australia
Declare that:	Retracta Hose Reel models prefixed AR, ARC, ARG, ARGC, AW, CL, CLC, CW, CWC, DR, DRC, FRAS, GR, GRC, HP, HPC, HW, HWC, LPG, LPGC, OA, OAC, OG, OGC, OMP, OMPC, RO, ROC, RY, RYC, WD & WDC		
in accordance with:	2006/42/EC 2009/127/EC		(The Machinery Directive) (amending Directive - WD, DR & DRC models only)
has been designed and manufactured to the following specifications:	EN ISO 12100: 2010 (Safety of Machinery)		
I hereby declare that the equipment named above has been designed to comply with the relevant sections of the above referenced specification. The product complies with all essential requirements of the Directives.			
Signed By:			
	Marco Uccellani, Engineering Manager, Macnaught Pty Ltd.		
Done at:	Macnaught Pty Ltd. 41-49 Henderson Street, Turrella, NSW 2205, Australia.		
Date:	26/08/2021		
			 <small>COM-DWGSPMURCA-R1.11 QA-CN749 Issued by R. Khan</small>

FR (French)		Déclaration de conformité	
Nous,	Macnaught Pty Ltd,	41-49 Henderson Street, Turrella NSW 2205, Australie	
Déclarons que	Les modèles d'enrouleurs de tuyaux Retracta aux préfixes: AR, ARC, ARG, ARGC, AW, CL, CLC, CW, CWC, DR, DRC, FRAS, GR, GRC, HP, HPC, HW, HWC, LPG, .PGC, OA, OAC, OG, OGC, OMP, OMPC, RO, ROC, RY, RYC, WD et WDC		
en vertu de :	2006/42/CE 2009/127/CE		(directive Machines) (directive modificative - modèles WD, DR et DRC uniquement)
sont conçus et fabriqués selon la spécification suivante :	EN ISO12100: 2010 (sécurité Machines)		
Je déclare par la présente que les équipements mentionnés ci-dessus sont conformes aux sections appropriées de la spécification susmentionnée. Le produit est conforme à toutes les exigences principales des directives.			
Signé par :			
	Marco Uccellani, responsable de l'ingénierie, Macnaught Pty Ltd.		
Fait à :	Macnaught Pty Ltd. 41-49 Henderson Street, Turrella, NSW 2205, Australie		
Date :	26/08/2021		
			 <small>COM-DWGSPMURCA-R1.11 QA-CN749 Issued by R. Khan</small>

DE (German)		Konformitätserklärungen	
Wir,	Macnaught Pty Ltd	mit Sitz in:	41-49 Henderson Street, Turrella NSW 2205, Australien
erklären, dass	die Retracta Schlauchtrommelmodelle mit den Präfixen AR, ARC, ARG, ARGC, AW, CL, CLC, CW, CWC, DR, DRC, FRAS, GR, GRC, HP, HPC, HW, HWC, LPG, LPGC, OA, OAC, OG, OGC, OMP, OMPC, RO, ROC, RY, RYC, WD und WDC		
in Übereinstimmung mit den Verordnungen:	2006/42/EG 2009/127/EG		(Maschinenrichtlinie) (Änderungsrichtlinie, nur Modelle WD, DR und DRC)
gemäß folgenden Spezifikationen konzipiert und hergestellt worden sind:	EN ISO12100: 2010 (Maschinensicherheit)		
Ich erkläre hiermit, dass die oben genannten Geräte so konzipiert wurden, dass sie mit den einschlägigen Abschnitten der oben genannten Spezifikation übereinstimmen. Das Produkt erfüllt alle grundlegenden Anforderungen der Richtlinien.			
Unterzeichnet von:			
	Marco Uccellani, Manager Ingenieurwesen, Macraught Pty Ltd.		
Unternehmen, Ort:	Macnaught Pty Ltd. 41-49 Henderson Street, Turrella, NSW 2205, Australien.		
Datum:	26/08/2021		
			 <small>COM-DWGSPMURCA-R1.11 QA-CN749 Herausgeber: Herr R. Khan</small>

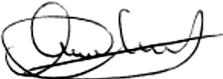
DECLARATION OF CONFORMITY

ES (Spanish)		Declaraciones de	
Nosotros:	Macnaught Pty Ltd	De	41-49 Henderson Street, Turrella NSW 2205, Australia
Declaramos:	Modelos Retracta Hose Reel con prefijo AR, ARC, ARG, ARGC, AW, CL, CLC, CW, CWC, DR, DRC, FRAS, GR, GRC, HP, HPC, HW, HWC, LPG, LPGC, OA, OAC, OG, OGC, OMP, OMPC, RO, ROC, RY, RYC, WD & WDC		
en conformidad con:	2006/42/EC 2009/127/EC		(La Directiva sobre maquinaria) (Directiva modificativa: solo los modelos WD, DR y DRC)
ha sido diseñada y fabricada de acuerdo con las siguientes especificaciones:			
	EN ISO 12100: 2010		(Seguridad de la maquinaria)
Por la presente declaro que el equipo mencionado anteriormente ha sido diseñado para cumplir con las secciones pertinentes de las especificaciones mencionadas con anterioridad. El producto cumple con todos los requisitos esenciales de las Directivas.			
Firmado por:			
	Marco Uccellani, Responsable de ingeniería, Macnaught Pty Ltd.		
Redactado en:	Macnaught Pty Ltd. 41-49 Henderson Street, Turrella, NSW 2205, Australia.		
Fecha:	26/08/2021		

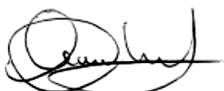

COM-DIMOTMURCA-RL-11
QA-C20149
Emitido por: X.Xxxx

JA (Japanese)		適合宣言書	
当社	Macnaught Pty Ltd	所在地:	41-49 Henderson Street, Turrella NSW 2205, Australia
は、次の製品が以下の指令及び仕様に準拠して設計、製造されていることを宣言します。			
製品:	AR, ARC, ARG, ARGC, AW, CL, CLC, CW, CWC, DR, DRC, FRAS, GR, GRC, HP, HPC, HW, HWC, LPG, LPGC, OA, OAC, OG, OGC, OMP, OMPC, RO, ROC, RY, RYC, WD, WDC の各種Retractaホースリールモデル		
指令:	2006/42/EC		(機械指令)
	2009/127/EC		(指令の修正 - WD, DR, DRC モデルのみ)
仕様:	EN ISO12100: 2010		(機械の安全性)
私は、上記の製品が上記仕様の関連セクションに適合するように設計されていることをここに宣言します。この製品は、本指令のすべての必須要求事項に準拠しています。			
署名:			
	Marco Uccellani, 技術管理者, Macnaught Pty Ltd		
住所:	Macnaught Pty Ltd. 41-49 Henderson Street, Turrella, NSW 2205, Australia.		
日付:	2021年08月26日		



COM-DIMOTMURCA-RL-11
QA-C20149
Emitido por: X.Xxxx

NOTES:

NOTES:

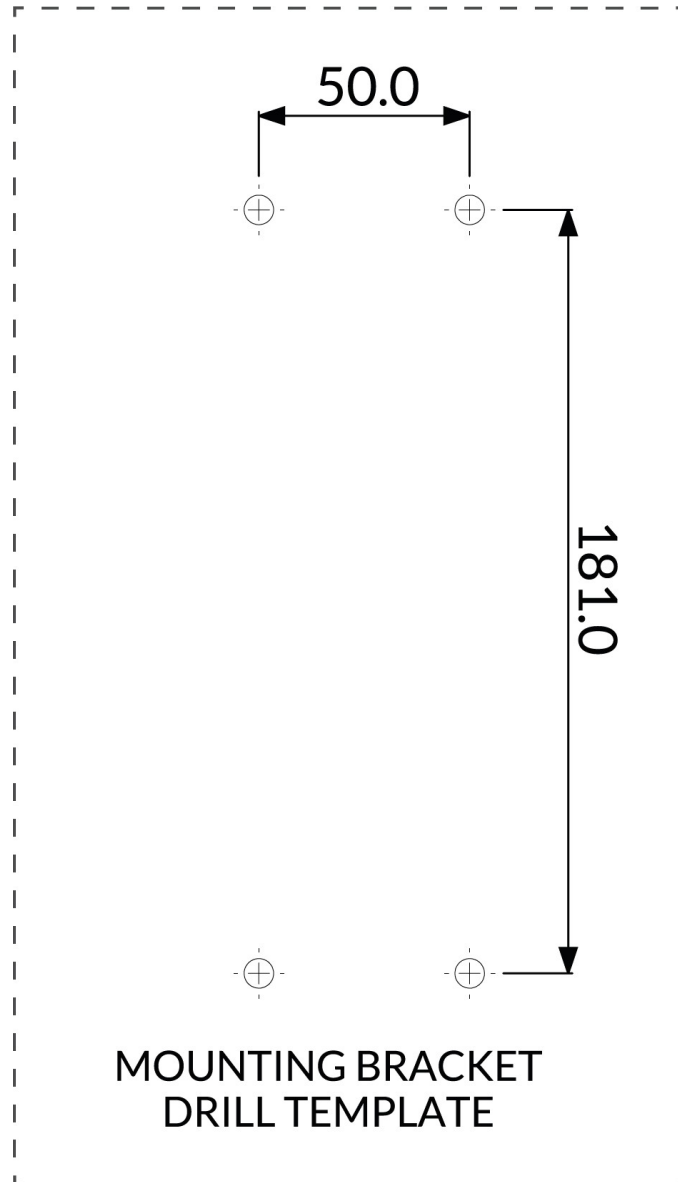

NOTE: Not to scale

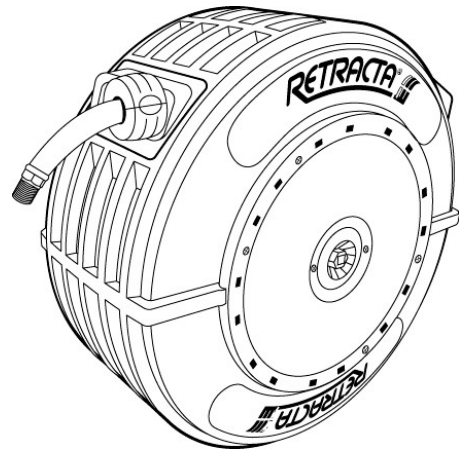

Macnaught Pty Limited
ABN 66 000 075 785

41 - 49 Henderson St
Turrella, NSW, 2205
Sydney, Australia.

Postal Address PO Box 90
Arncliffe NSW 2205 Sydney,
Australia.

T. +61 2 9567 0401
F. +61 2 9597 7773
W. www.macnaught.com.au

Note:

This product should be disposed of according to all applicable local and national government environment regulations and guidelines.



For Warranty Terms and Conditions see macnaught.com.au
For a list of Australian Service Centres see macnaught.com.au